

**80100314**

## Monopolar Cable

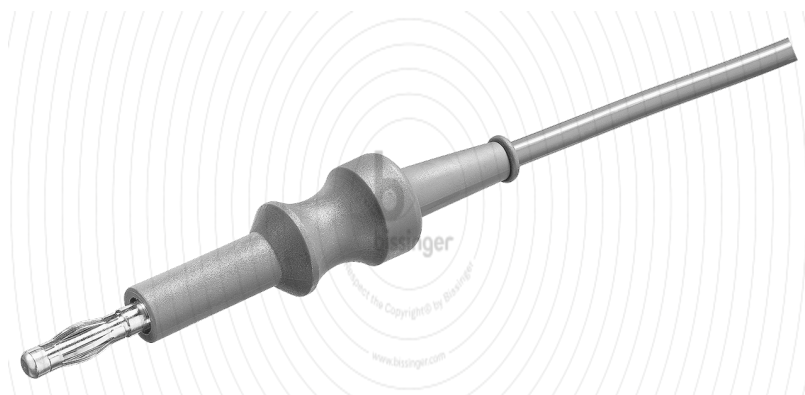

## Technical specifications

### Dimensions and Weights

Cable length	3 m
--------------	-----

### Basic Specifications

Cable connector instrument side	2 mm Plug protected for Resectoscope
Cable plug generator side	Erbe T-Serie, Martin, Berchtold

### Cleaning and Reprocessing

Reusable	Yes
Manual reprocessing	Yes, related to IFU
Washing machine	95 °C
Autoclave sterilization	max. 137 °C

### Approvals

Directive 93/42 EEC	N/A
Regulation (EU) 2017/745	Class I
FDA Approval	Class II

### Additional Product Information

Accessories rated voltage	max. 5 kVp
Packaging unit	1
GTIN 14	04250418701266