

**80100317**

## Monopolar Cable

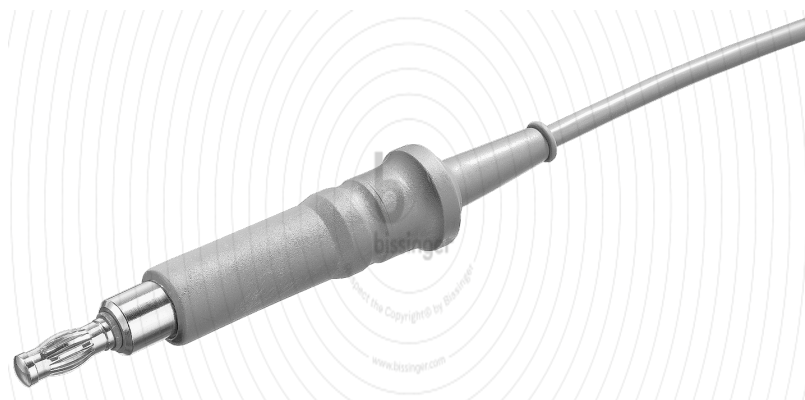
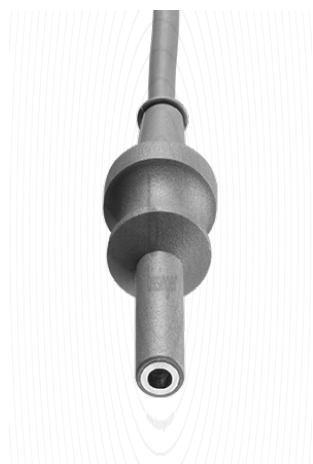

## Technical specifications

### Dimensions and Weights

Cable length	5 m
--------------	-----

### Basic Specifications

Cable connector instrument side	3 mm Socket
Cable plug generator side	Erbe ACC/ICC

### Cleaning and Reprocessing

Reusable	Yes
Manual reprocessing	Yes, related to IFU
Washing machine	95 °C
Autoclave sterilization	max. 137 °C

### Approvals

Directive 93/42 EEC	N/A
Regulation (EU) 2017/745	Class I
FDA Approval	Class II

### Additional Product Information

Accessories rated voltage	max. 5 kVp
Packaging unit	1
GTIN 14	04250418701297